

EMMA BALCONY FOTEL

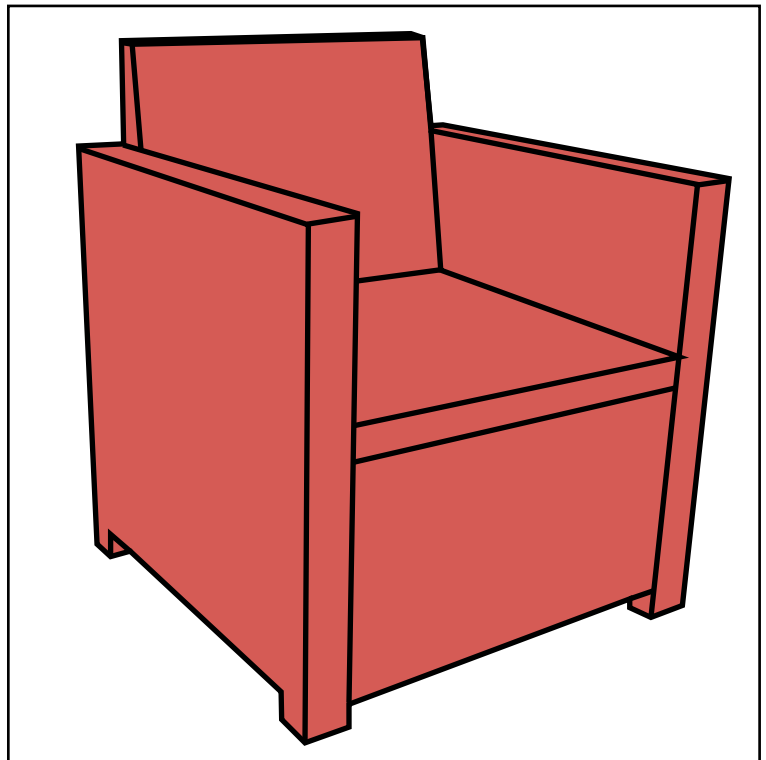

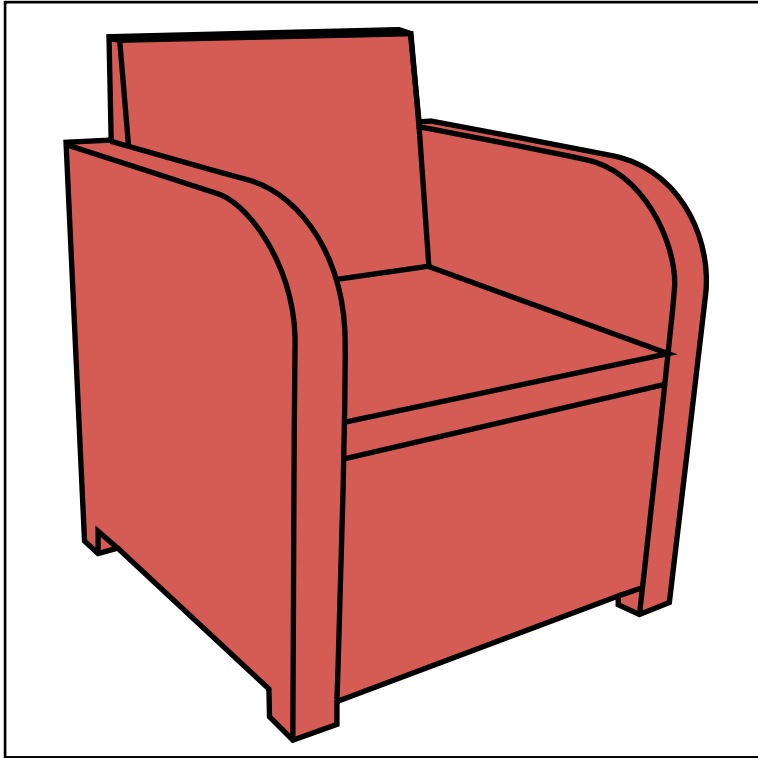

NEN 581

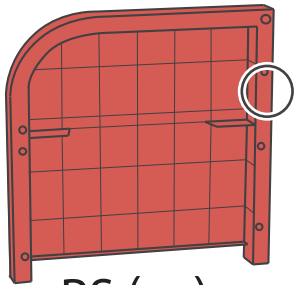
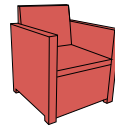
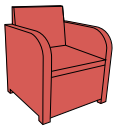

RS (1 x)

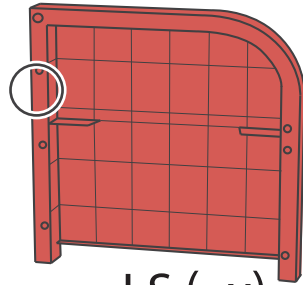

LS (1 x)

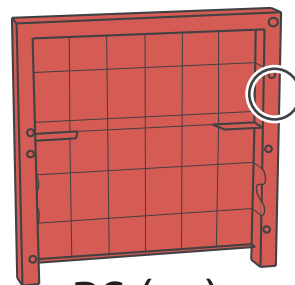

RS (1 x)

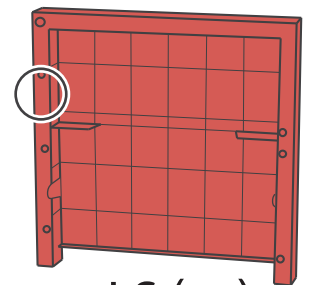

LS (1 x)

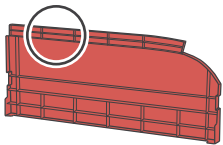

SCR (1 x)

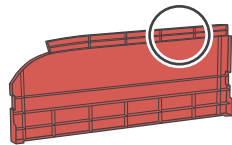

SCL (1 x)

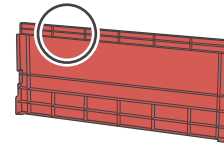

SC (2 x)

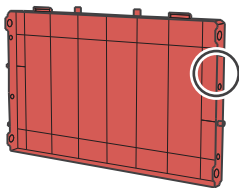

F1 (1 x)

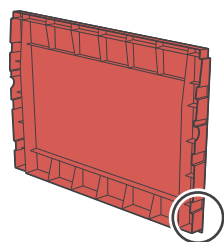

BC1 (1 x)

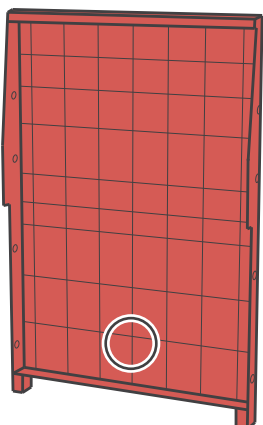

B1 (1 x)

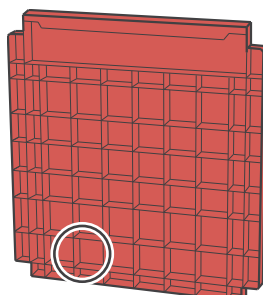

S1 (1 x)

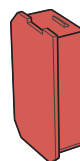

NA (2 x)

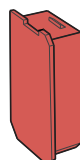

NB (2 x)

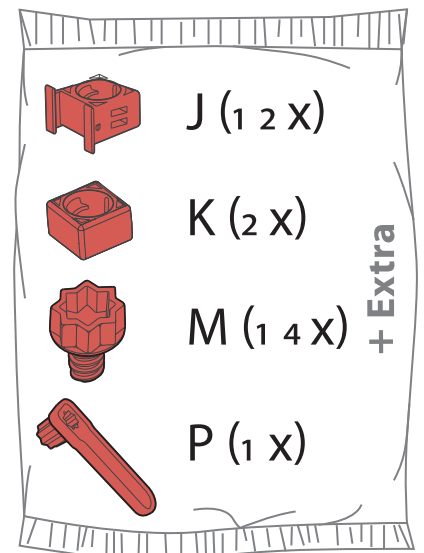

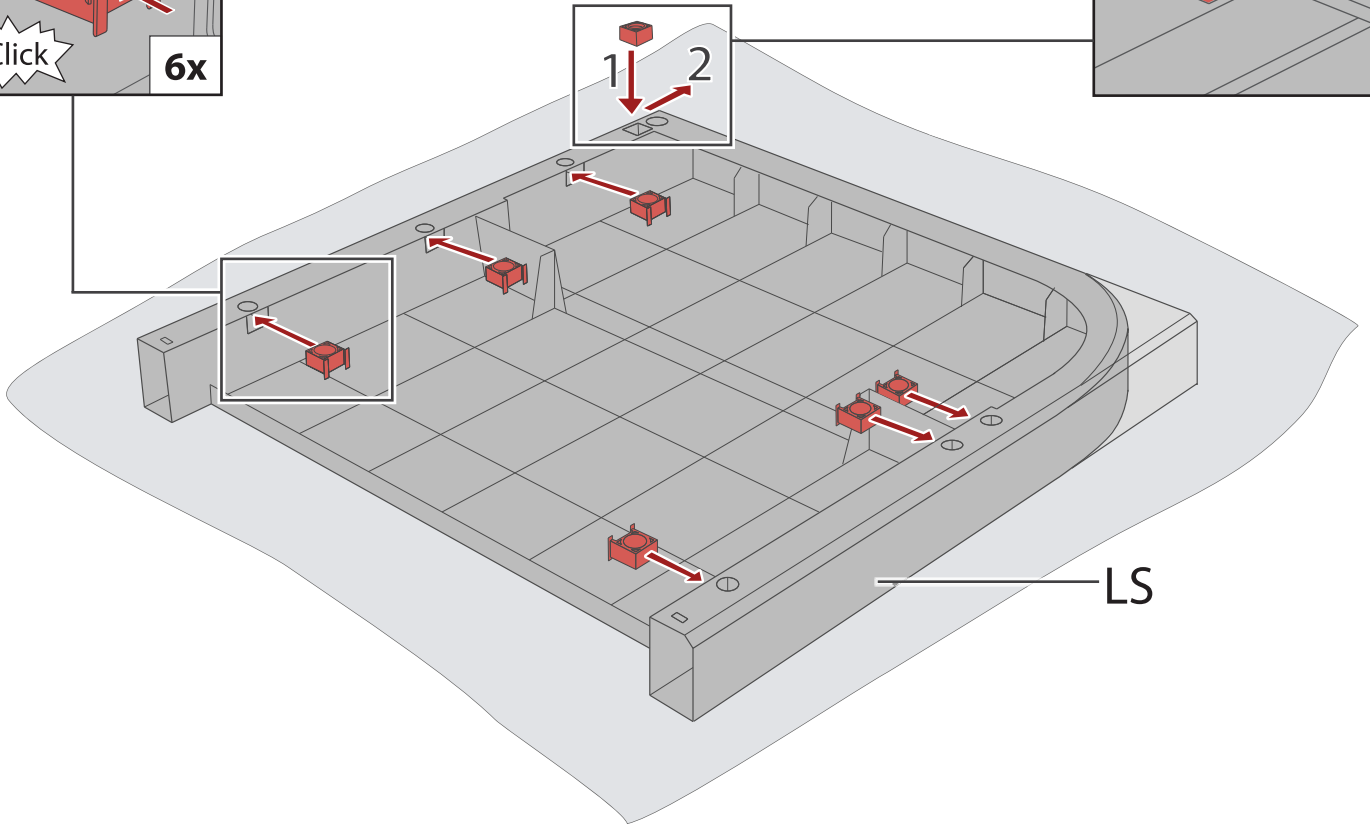
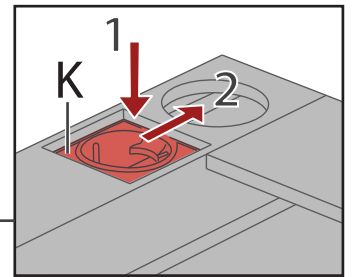
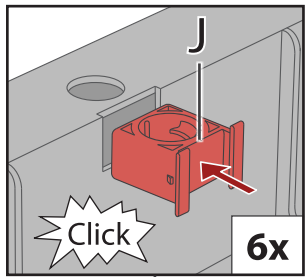

1

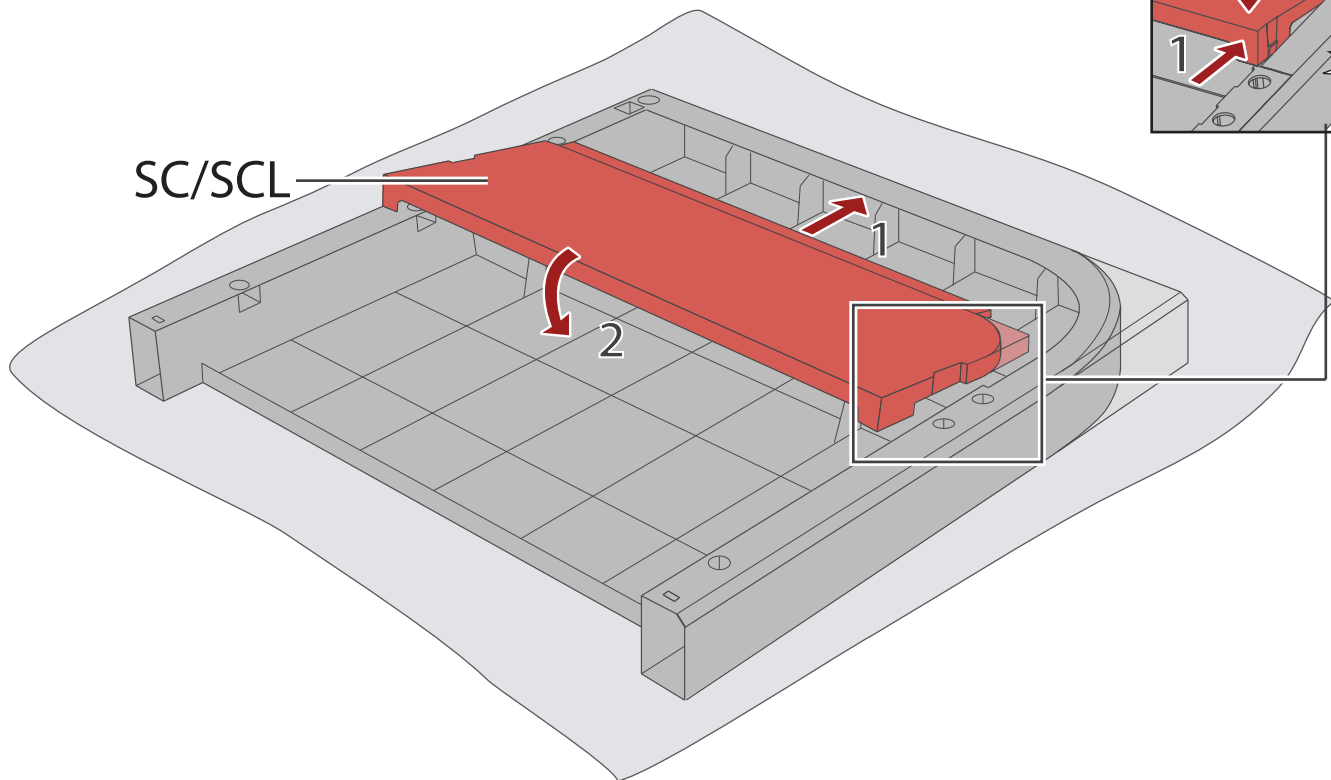
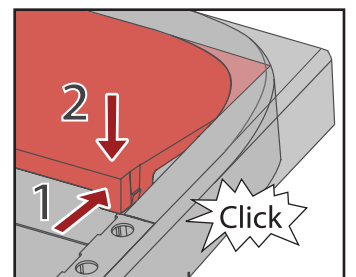

2

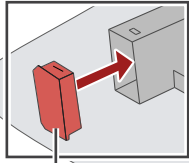
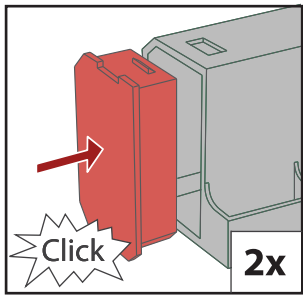

NA

NB

3

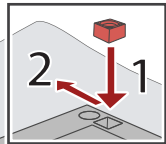
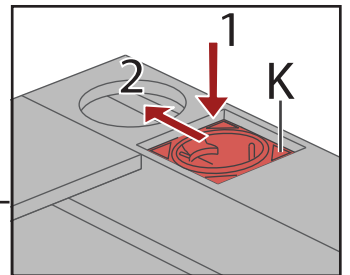
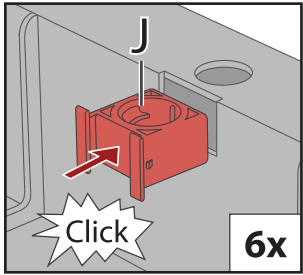

RS

4

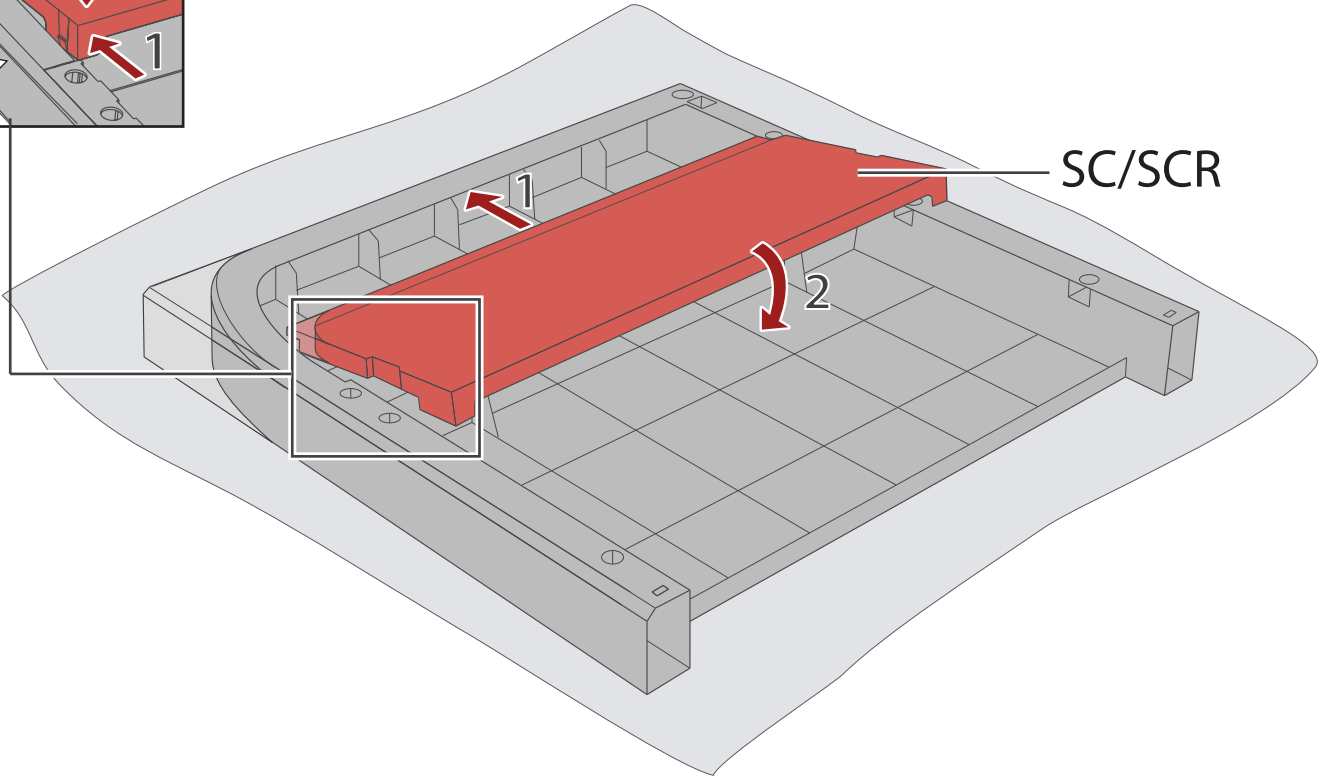
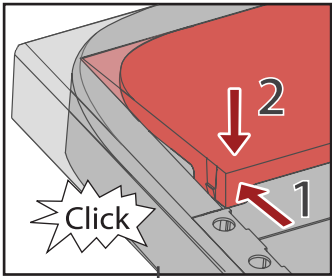

5

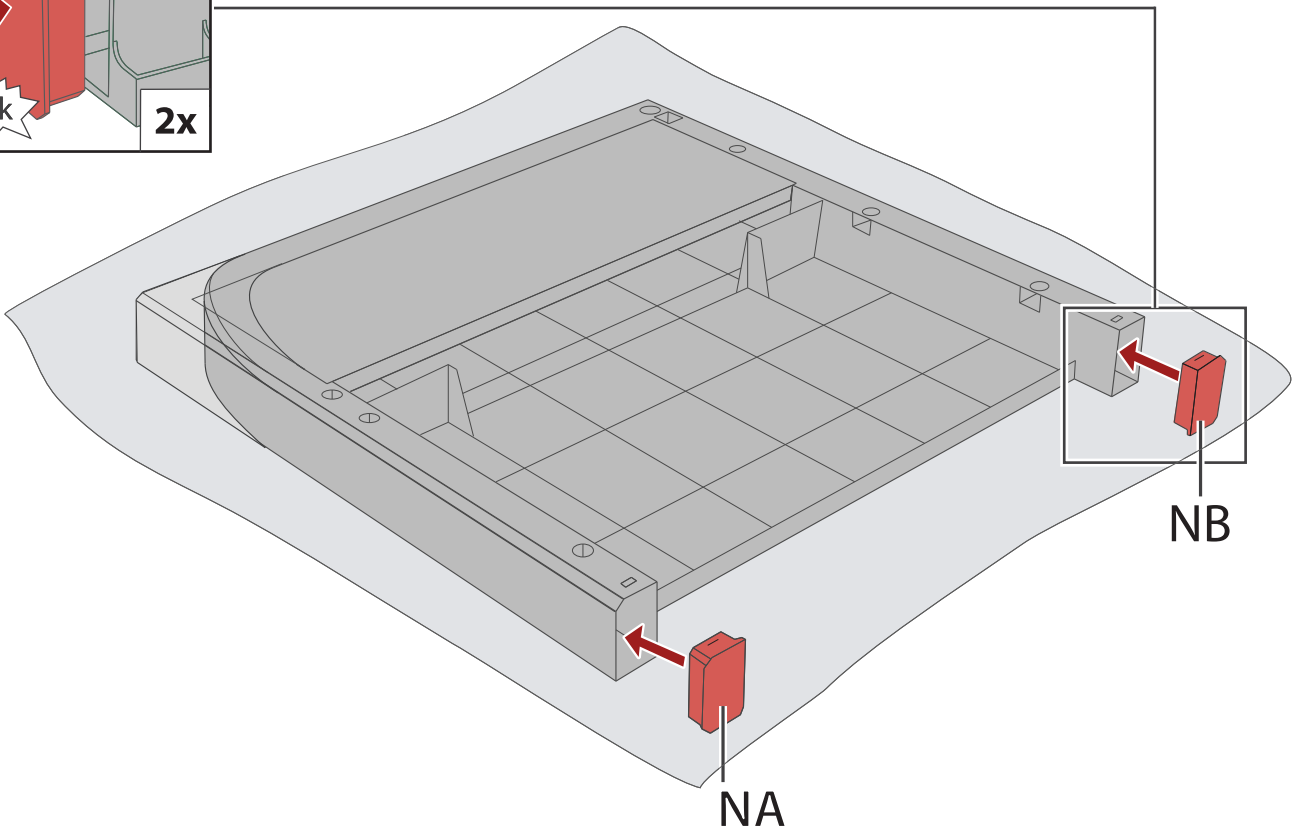
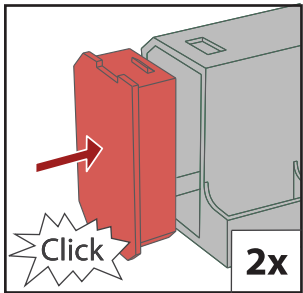

6

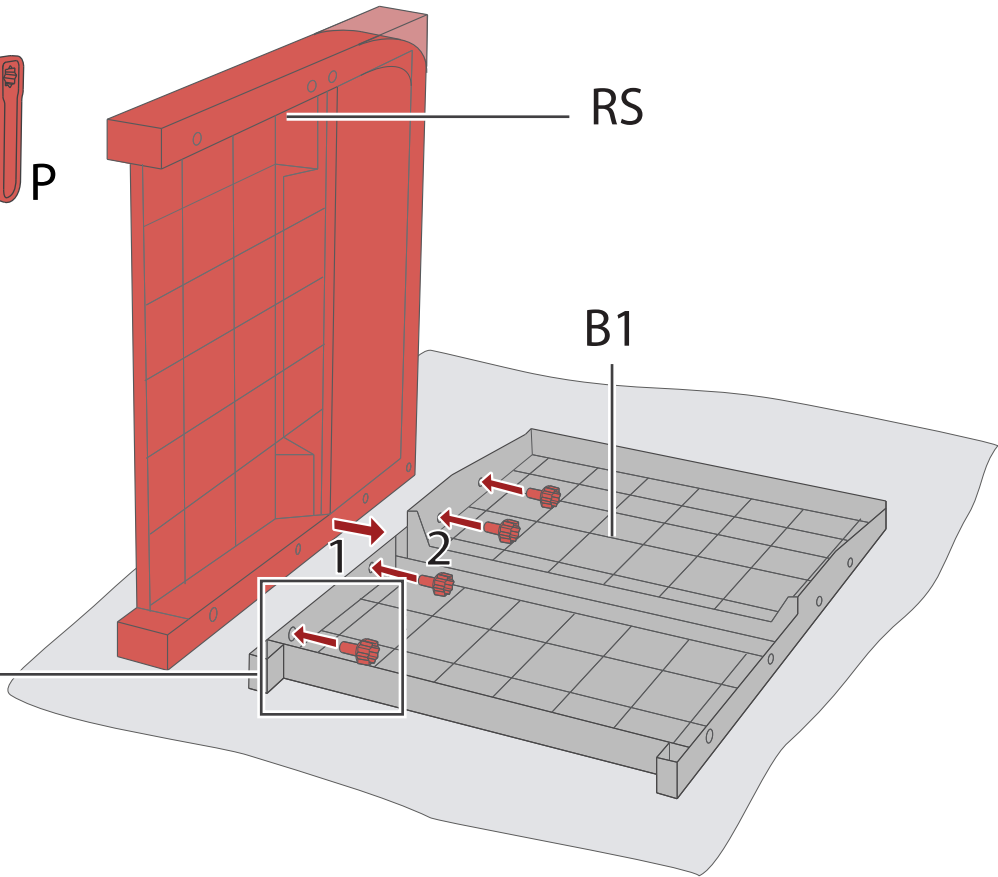
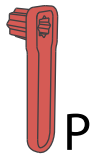
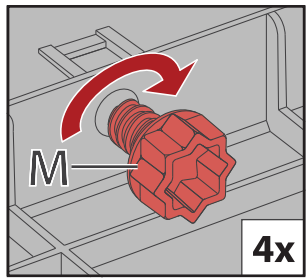

7

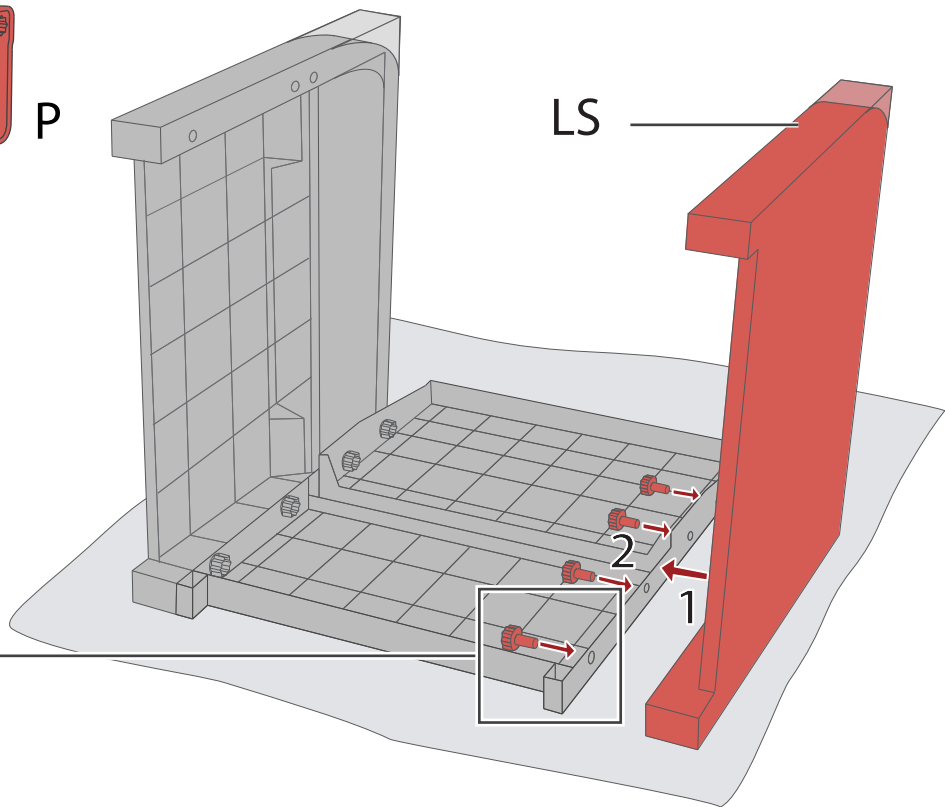
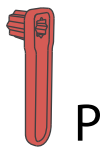
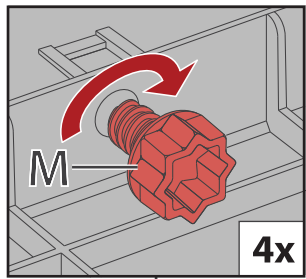

8

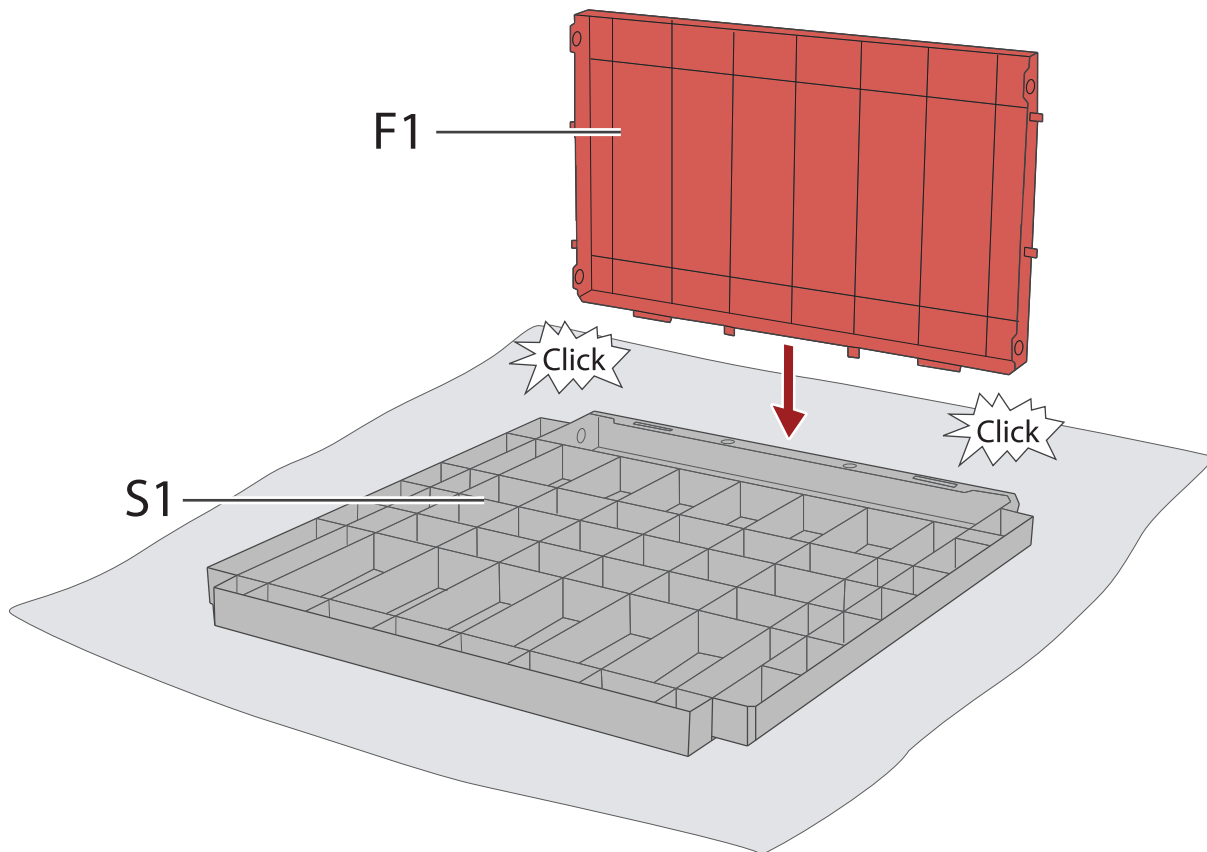

9

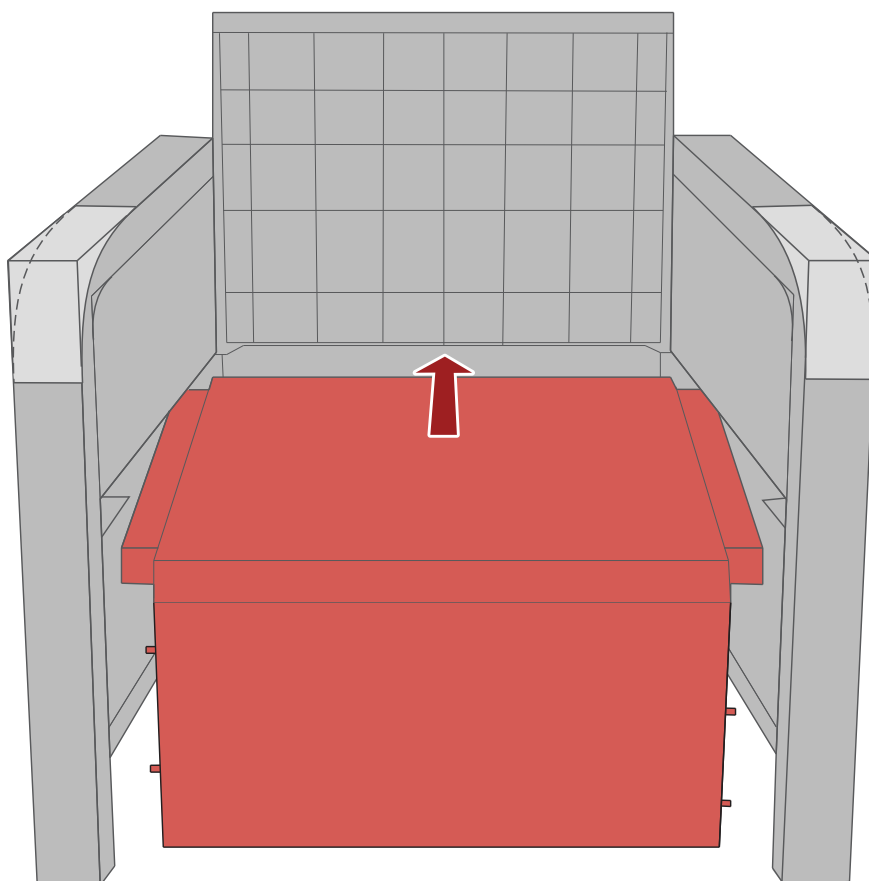

10

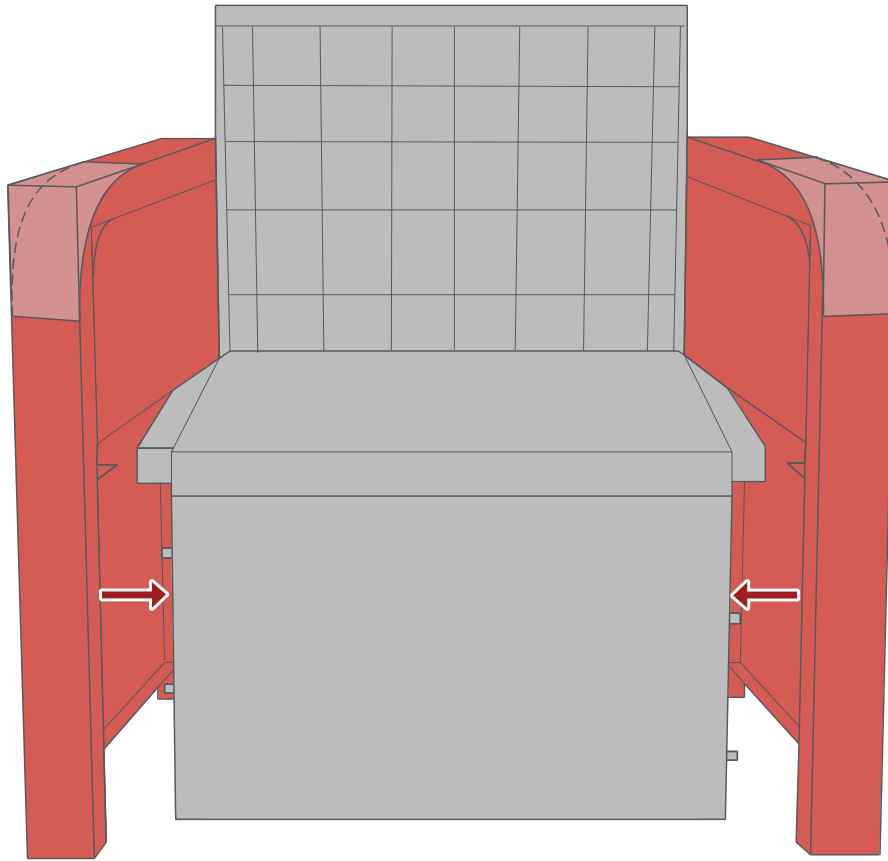

11

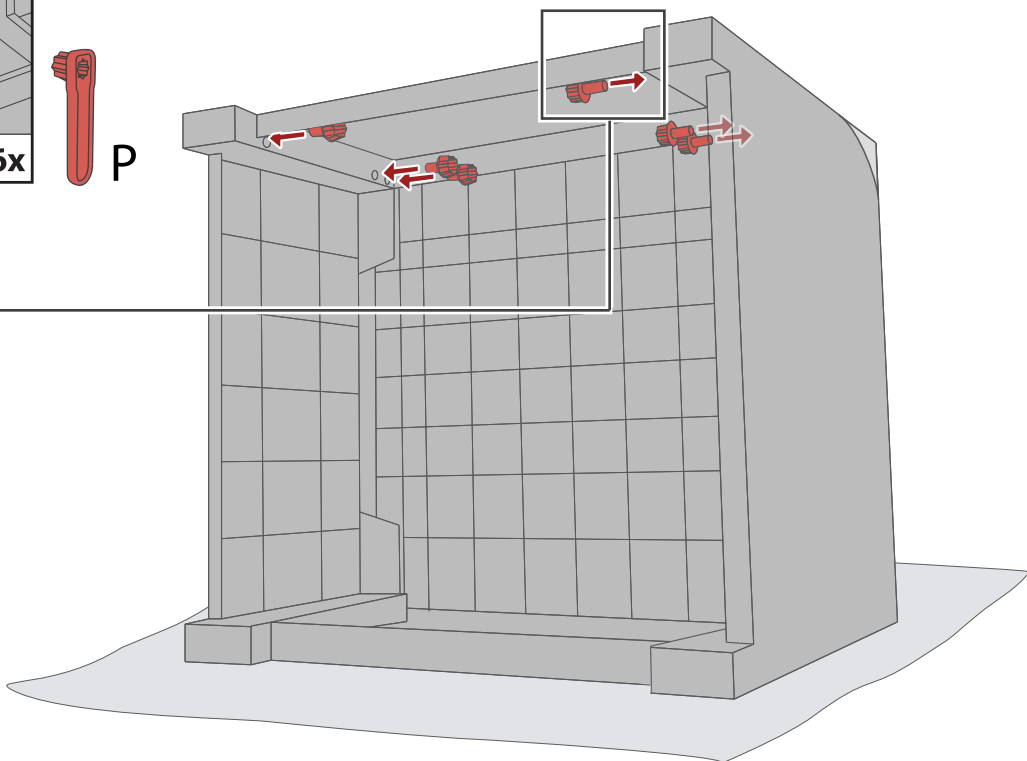
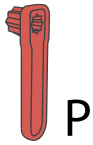
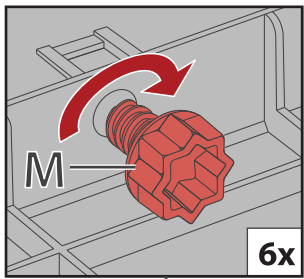

12

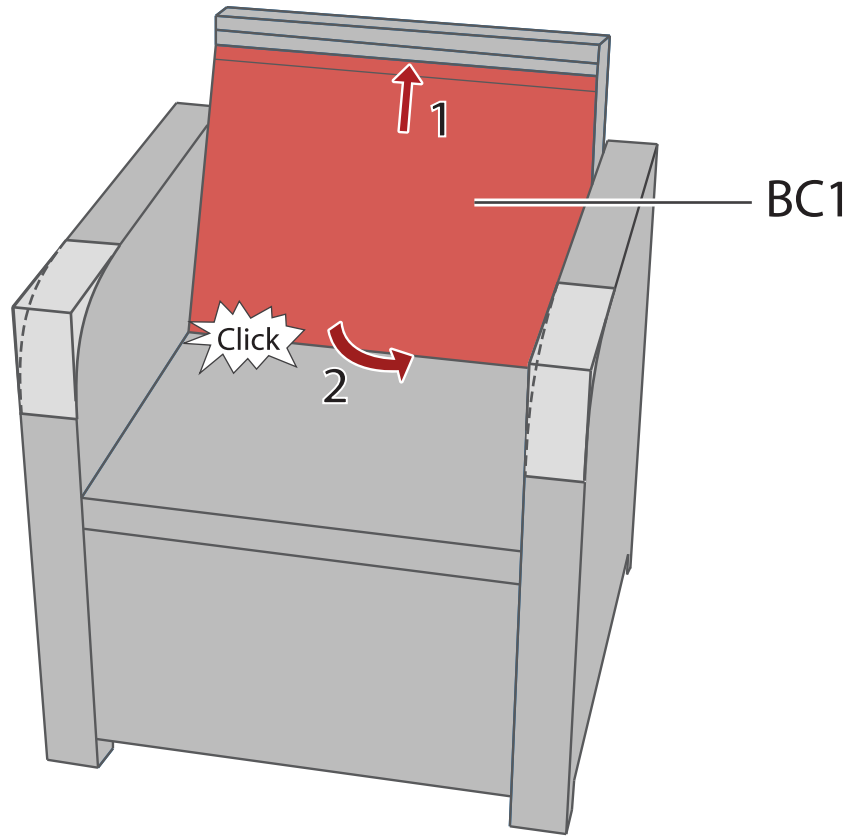
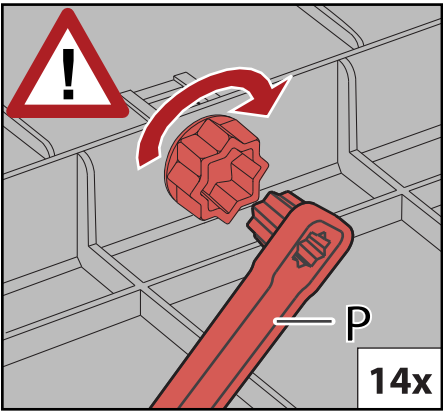

13

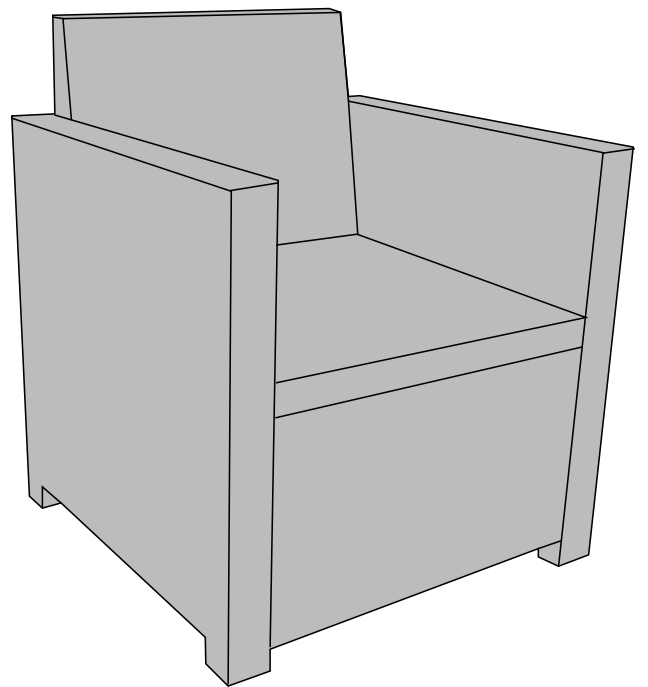
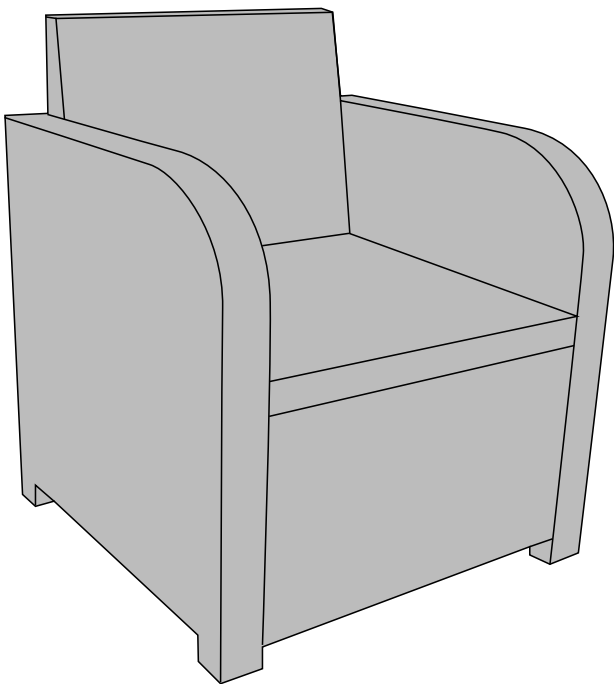

14